

TRIGANO
J A R D I N

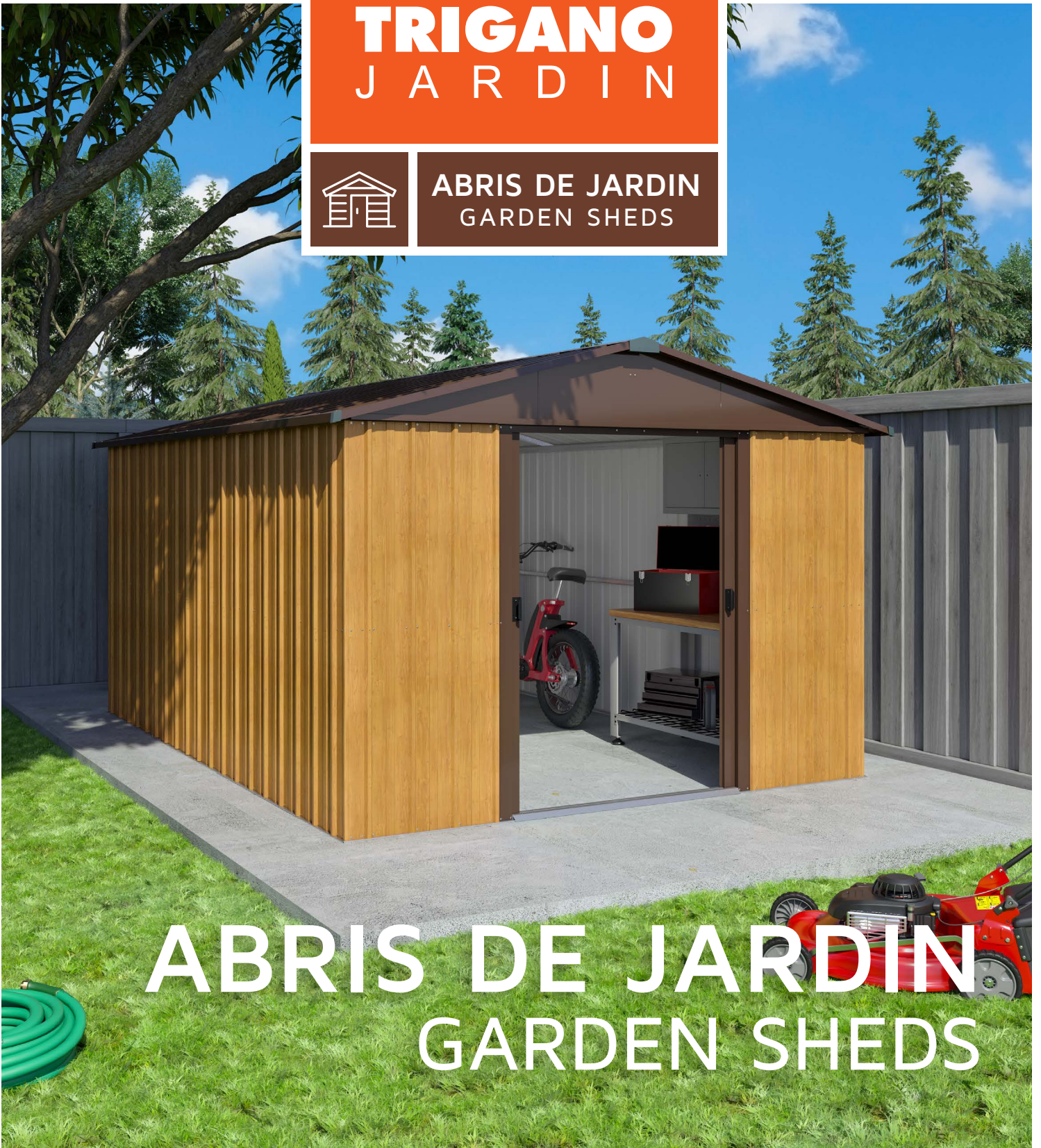

ABRIS DE JARDIN
GARDEN SHEDS



ABRIS DE JARDIN
GARDEN SHEDS



triganojardin.com

Les valeurs Trigano

Our values

Spécialiste de l'équipement du jardin made in France, Trigano Jardin fabrique et commercialise des jeux de plein air et des piscines familiales hors sol sous la marque Aléo by Trigano, ainsi que des carports sous la marque Trigano. La qualité, l'innovation et l'esthétisme sont au cœur de la conception des produits de Trigano Jardin.

Trigano Jardin est également le distributeur exclusif des produits Yardmaster. Fabricant européen d'abris de jardin en métal, Yardmaster est une filiale du groupe Trigano. Sa solide expérience de plus de 35 ans ainsi que son volume de fabrication permettent un réassort permanent à destination des magasins.

Specialist of the Made in France Outdoor Equipment, Trigano Jardin manufactures and markets outdoor games and above-ground family pools under the « Aléo by Trigano » brand as well as Trigano branded carports.

Quality, innovation and aesthetics are at the heart of the design of Trigano Jardin products.

Trigano Jardin is also the exclusive distributor of Yardmaster products in various countries. European manufacturer of metal garden sheds, Yardmaster is a subsidiary of the Trigano group. Its solid experience of more than 35 years as well as its manufacturing volume allow permanent restocking for retailers.



Notre site de production
Our production site

Service
Contrôle-Qualité
Quality Control dpt.



Respect de
l'environnement
Respect of the
environment



TRIGANO
JARDIN



Innovation
Innovation



Entreprise
française
French company

Trigano,

un groupe reconnu...

L'histoire de Trigano remonte à 1935 quand la famille Trigano lance la commercialisation d'articles textile. L'année suivante, les Français partent pour la première fois en congés payés et Trigano leur fournit leurs premières toiles de tentes : ce sont les débuts du camping. Devenu le symbole des vacances, de l'évasion et de la liberté, Trigano a su s'imposer et séduire des millions d'Européens en étant toujours à l'écoute de leurs aspirations.

Depuis plus de quatre-vingts ans, le savoir-faire de Trigano combiné à une politique volontariste en matière d'innovation et de qualité ont fait de l'entreprise la référence européenne dans le domaine des véhicules de loisirs et de l'équipement de plein-air.

Trigano, a recognized group...

Trigano's story began in 1935, when Edgard Trigano and his family created their own brand of clothing. The following year, paid holidays were introduced in France and Trigano provided the French with their first tents: these were the early days of camping. The company quickly became synonymous with holidays, getting away from it all and freedom. Trigano has succeeded in carving out a place for itself because it listened to the aspirations of its millions of European customers. The Trigano group's know-how, its determination to innovate and its targeted strategy of external growth led it to become the European benchmark for leisure vehicles and outdoor recreational equipment.



ABRIS

Garden sheds

4

Gammes GPE / GPZ / SP 8

GPE / GPZ / SP sheds

Gamme GEYZ

GEYZ sheds

10

Gamme AEYZ

AEYZ sheds

12

Gamme WGY

WGY sheds

14

Gamme TBSL

TBSL sheds

16

Gamme GARAGE

GARAGE

18

Kits planchers

Floor kits

20

Dimensions

Dimensions

21

Sommaire

Summary



ÉTENDOIRS 22

Clothes lines

Hélios 22

Windy 22



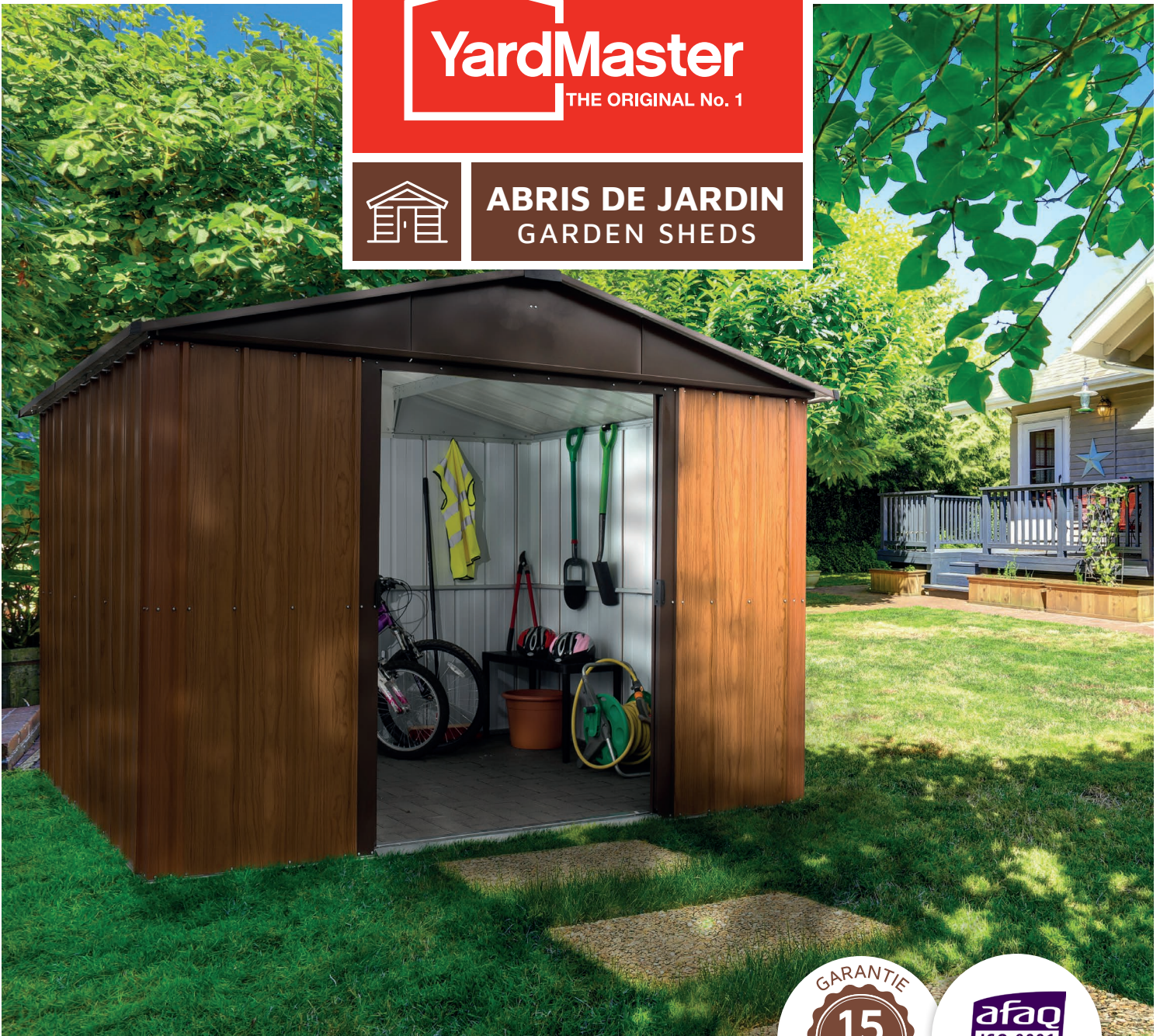

Pourquoi choisir un abri de jardin YardMaster ?

Why choose a YardMaster garden shed ?

- > **Excellent rapport qualité/prix**
Great value for money
- > **Produits de qualité supérieure, garantis 15 ans contre la rouille**
Premium quality products backed by a 15-year anti-rust warranty
- > **Solidité et longévité grâce à l'acier galvanisé et au traitement anticorrosion (7 couches de protection)**
Solidity and durability thanks to galvanised steel and the no corrosion protection (reinforced with 7 layers of protection)
- > **Facile à installer et sans entretien**
Easy to assemble and maintenance free



YardMaster :
1^{er} fabricant européen
d'abris de jardin
et garages métal !

YardMaster: Europe's top
manufacturer of metal sheds
and garages!



Comment installer un abri de jardin ?

How to put up a garden shed ?

- 1 **Préparation du sol : plancher bois ou dalle béton**
Ground preparation : wooden floor or concrete slab
- 2 **Installation des rails au sol**
Installation of rails on the ground
- 3 **Montage des panneaux muraux**
Mounting wall panels
- 4 **Assemblage du toit et des portes**
Roof and doors assembly
- 5 **Serrage final et ancrage au sol**
Final tightening and floor anchoring



Bon à savoir !

L'abri de jardin doit être monté avec des conditions météorologiques favorables.

Good to know: the garden shed must be put up with favorable weather conditions.



Quelle superficie choisir ?

Which overall surface to choose?

- > **Pour un lieu de stockage : 1 à 6 m²**
For a storage place: 1 to 6 m²
- > **Pour un atelier ou pour stocker du matériel encombrant : 6 à 12 m²**
For a workshop or to store bulky equipment: 6 to 12 m²
- > **Pour une voiture : garage de 15 à 23 m²**
For a car: garage from 15 to 23m²



Bon à savoir !

Pour ne pas se tromper dans la taille de son futur abri de jardin, il est important de réfléchir aux objets et outils qui y seront entreposés en gardant une marge de manœuvre de 20% supplémentaire environ.

Good to know: To avoid making mistakes in the size of your future garden shed, it is important to think about the objects and tools that will be stored there, keeping a safety margin of about 20%





Quelques configurations types

Some typical configurations

Petit / small

Pour mobilier de jardin et petit matériel

- A Matelas de transat B Table de jardin pliante
- C Chaises empilables D Tondeuse E Étagères

For garden furniture and small equipment

- A Deckchair mattress B Folding garden table
- C Stackable chairs D Mower E Shelves

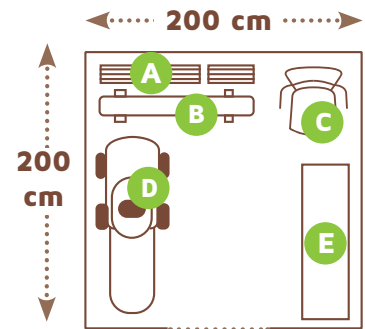

Moyen / medium

Pour mobilier et matériel encombrant

- A Hamac B Vélos C Tondeuse autoportée
- D Coupe-bordures E Rangement au mur d'outils

For furniture and bulky equipment

- A Hammock B Bikes C Self-propelled mower
- D Lawn edger E Storage on the wall of tools

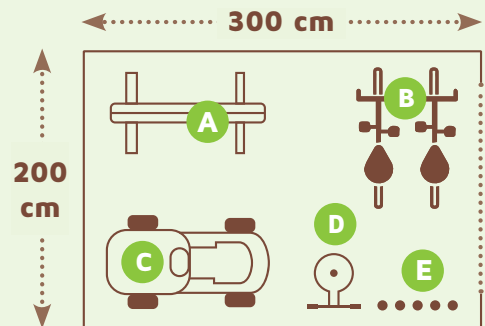

Grand / large

Pour toute la famille

- A Matelas de transat B Table de jardin pliante
- C Chaises empilables D Barbecue
- E Vélos parents et enfant F Brouette
- G Tondeuse autoportée H Rangement au mur d'outils
- I Coupe-bordures J Portique bébé K Étagères

For the whole family

- A Deckchair mattress B Folding garden table
- C Stackable chairs D Barbecue
- E Parents and child's bikes F Wheelbarrow
- G Self-propelled mower H Storage on the wall of tools
- I Lawn edger J Baby swing set K Shelves

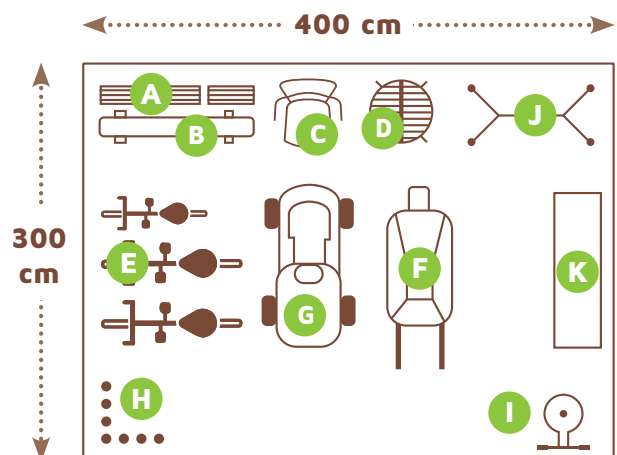

Avantages Advantages

Panneaux de toit translucides (selon modèle)

Translucent roof panels
(depending on model)



Grandes hauteurs de porte de 60 x 158 cm à 120 x 178 cm

Extra tall door
60 x 158 cm to 120 x 178 cm

Ventilation le long du toit contre l'humidité

Ventilation along roof ridge and eaves
against moisture



Gouttières de toit pour des murs plus propres (selon modèle)

Roof guttering helps
maintain cleaner walls
(depending on model)



Structure robuste : entretoisement intérieur pour davantage de solidité

Robust structure :
Interior wall bracing
for added strength

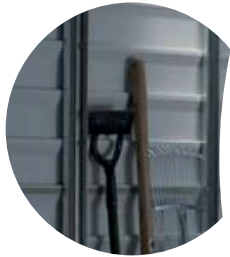

Doubles portes coulissantes : empêche la pénétration de la pluie et de la neige

Overlapping double sliding doors :
Keeps out rain and snow



Support de plancher (P.20) (non inclus)

Floor support frame (P.20)
(not included)

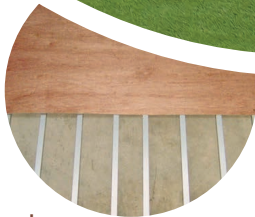

Visserie anti-rouille Anti-rust screws and bolts



Kit d'ancrage inclus pour un maintien optimal Anchor kit for optimum support

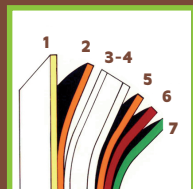

1 Couche déperlante
Wash reverse

2 Couche passivante
Oxide layer

**3-4 Acier galvanisé
à chaud (x2)**
Full immersion process (x2)
hot dipped galvanised steel

5 Couche passivante
Oxide layer

6 Couche d'apprêt
Primer coat

7 Couche de finition
Finish coat

Épaisseur des murs et toit : 0,25 mm
Wall and roof thickness

Épaisseur du fronton et
de la porte : 0,5 mm
Front and door thickness

LÉGENDE PICTOGRAMMES ICONS KEY

KG Poids
Weight

**PCB
MOQ** Par combien
Minimum Order
Quantity

Colisage
Packaging

Hauteur de porte
Door height

GAMME

GPE / GPZ / SP

REMISES MÉTAL
METAL SHEDS



Faible encombrement au sol

Small surface required

RÉFÉRENCES PRODUITS / PRODUCTS REFERENCES



KG	PCB MOQ		
44	7	1	158

54GPE

EAN : 3 222 877 655 405

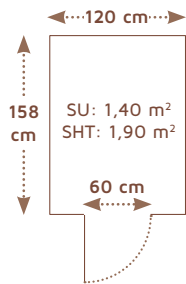

KG	PCB MOQ		
47	10	1	158

64GPZ

EAN : 3 222 877 666 401

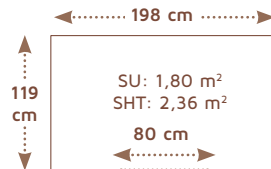

KG	PCB MOQ		
58	7	1	158

84GPZ

EAN : 3 222 877 668 405

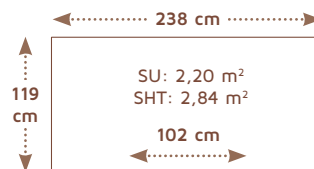

KG	PCB MOQ		
70	7	1	158

104GPZ

EAN : 3 222 877 661 048

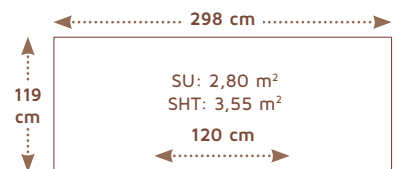

KG	PCB MOQ		
70	7	1	180

85SP18

EAN : 5 013 546 063 014

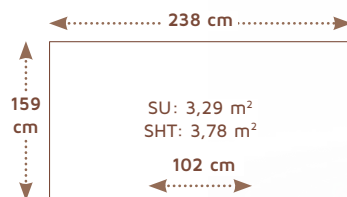

LES + PRODUIT Advantages of this product



Ventilation le long du toit
Ventilation along roof ridge and eaves



Kit d'ancrage
Anchor kit

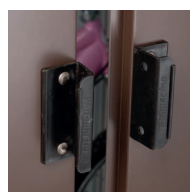

Doubles portes coulissantes*
Overlapping double sliding doors*

* sauf 54GPE : 1 porte battante
except 54GPE : 1 swing door



Fronton translucide*
Translucent gable*
* uniquement pour le 85SP18
only for the 85SP18

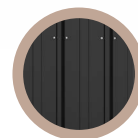

GAMME

GEYZ

ABRIS MÉTAL VERTS
GREEN METAL SHEDS

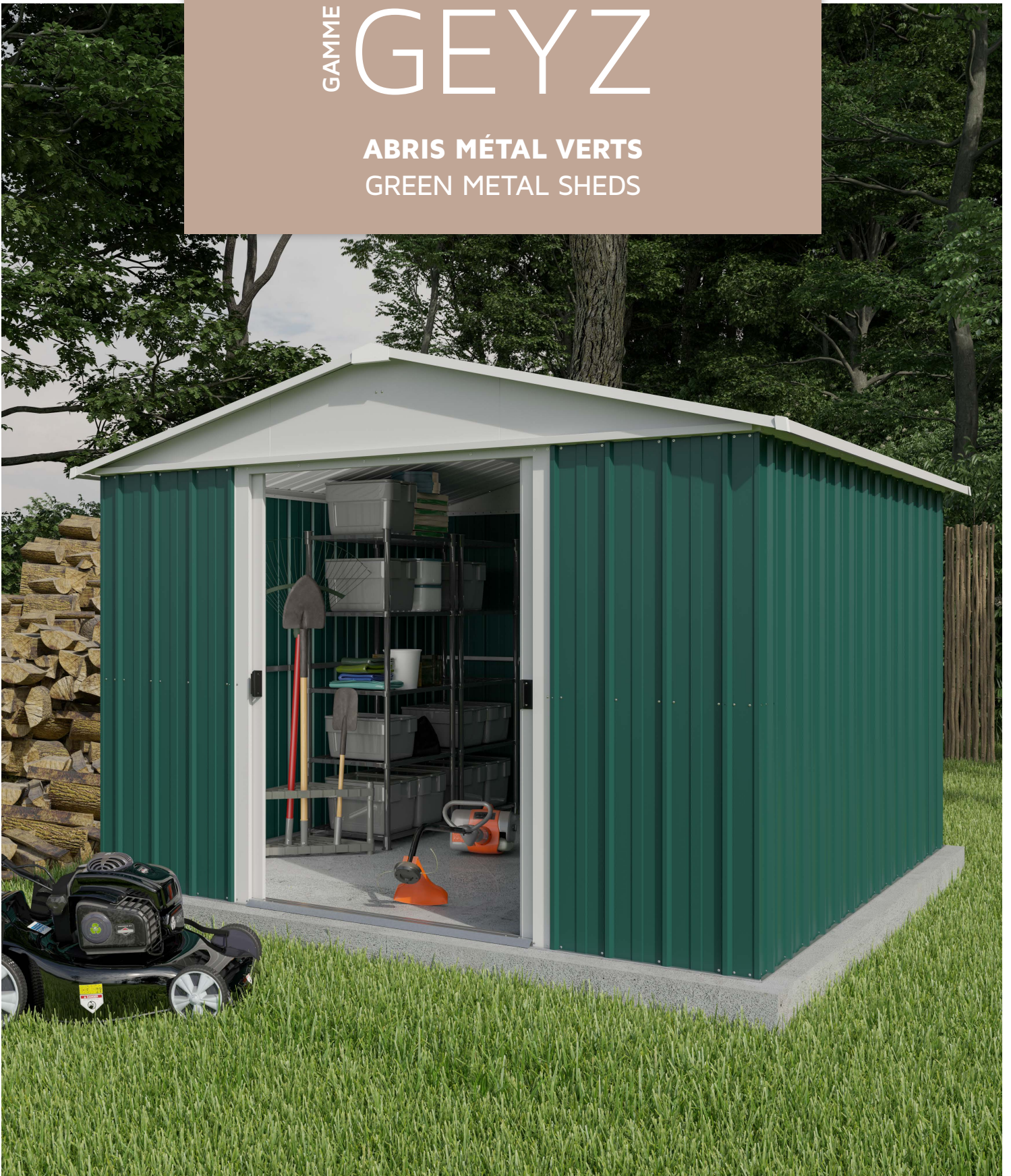

Son coloris s'intègre
harmonieusement au jardin

Its colour blends into the garden

RÉFÉRENCES PRODUITS / PRODUCTS REFERENCES

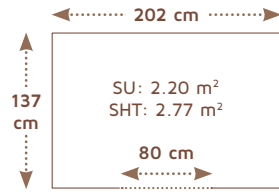

KG	PCB MOQ		
56	14	1	158

65GEYZ
EAN : 3 222 873 006 508

KG	PCB MOQ		
71	14	1	158

67GEYZ
EAN : 3 222 873 006 706

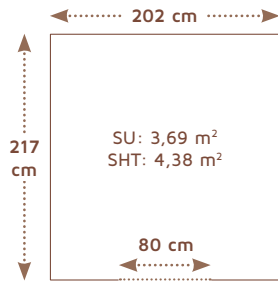

KG	PCB MOQ		
73	6	1	158

87GEYZ
EAN : 3 222 877 008 706

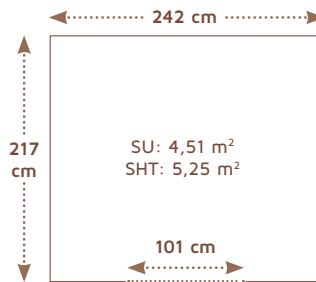

KG	PCB MOQ		
99	6	2	158

108GEYZ
EAN : 3 222 877 010 808

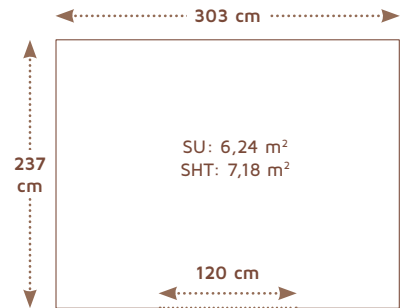

KG	PCB MOQ		
105	6	2	158

109GEYZ
EAN : 3 222 873 109 100

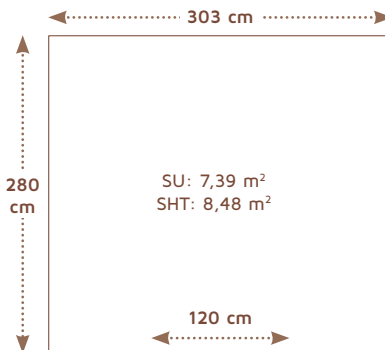

KG	PCB MOQ		
110	6	2	158

1010GEYZ
EAN : 3 222 873 110 106

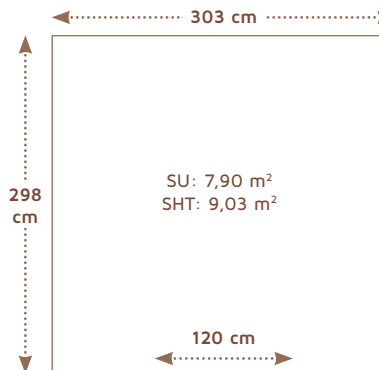

KG	PCB MOQ		
150	6	2	158

1013GEYZ
EAN : 3 222 877 101 308

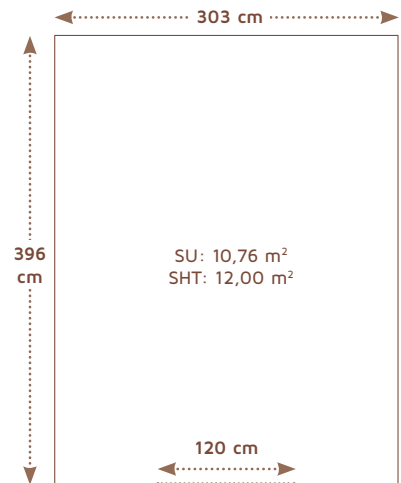

LES + PRODUIT Advantages of this product



Grandes hauteurs de toit
Lots of headroom



Ventilation le long du toit
Ventilation along roof ridge and eaves



Kit d'ancrage
Anchor kit



Structure de toit renforcée (double poutre)
Reinforced roof structure (double beams)

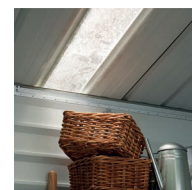

Panneaux de toit translucides*
Translucent roof panels*
* uniquement pour le 1013GEYZ
only for the 1013GEYZ



GAMME **A E Y Z**

ABRIS MÉTAL ANTHRACITE
ANTHRACITE METAL SHEDS

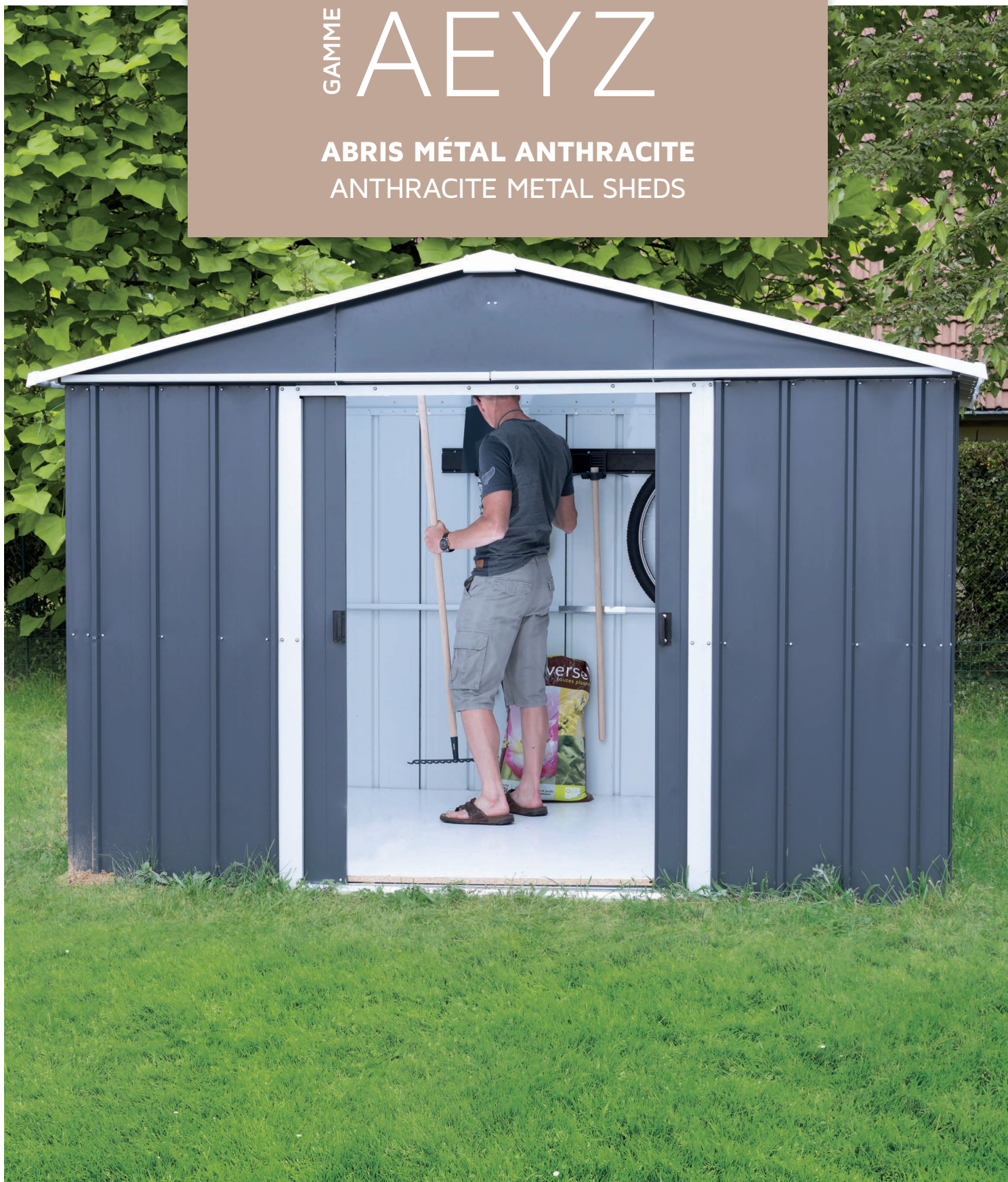

**Son coloris moderne apporte
une réelle valeur ajoutée**

Its modern colour is a real added value

RÉFÉRENCES PRODUITS / PRODUCTS REFERENCES

KG	PCB MOQ		
63	14	1	158

65AEYZ

EAN : 3 222 871 506 505

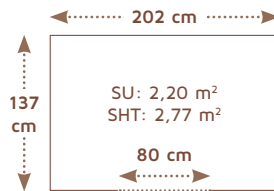

KG	PCB MOQ		
70	14	1	158

67AEYZ

EAN : 3 222 871 506 703

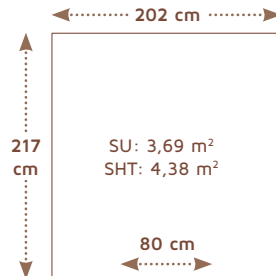

KG	PCB MOQ		
91	6	2	158

106AEYZ

EAN : 3 222 871 510 601

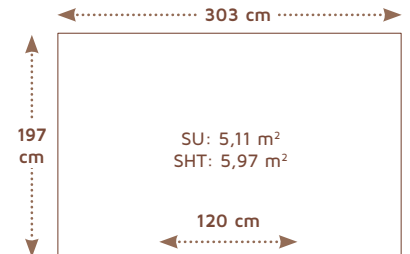

KG	PCB MOQ		
99	6	2	158

108AEYZ

EAN : 3 222 871 510 809

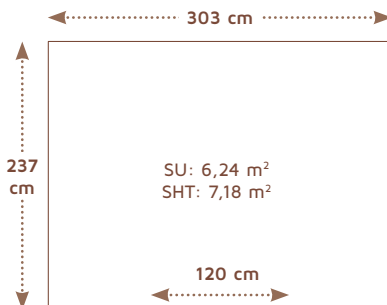

KG	PCB MOQ		
110	6	2	158

1010AEYZ

EAN : 3 222 871 510 106

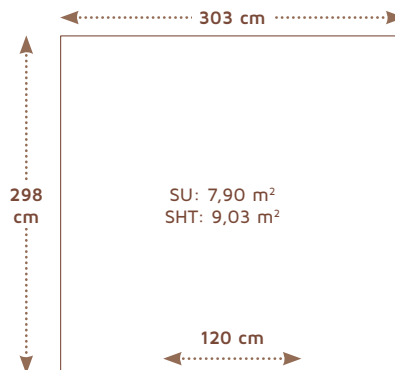

KG	PCB MOQ		
151	6	2	158

1013AEYZ

EAN : 3 222 871 510 137

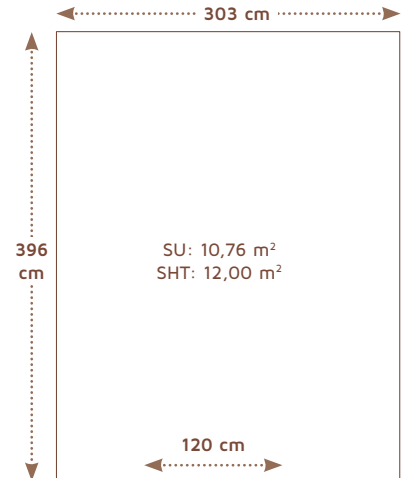

LES + PRODUIT

Advantages of this product

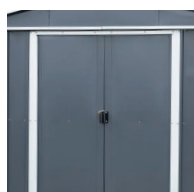

Grandes hauteurs de toit
Lots of headroom

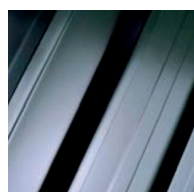

Robustesse et esthétique
Strength and good looks



Kit d'ancrage
Anchor kit



Structure de toit renforcée (double poutre)
Reinforced roof structure (double beams)

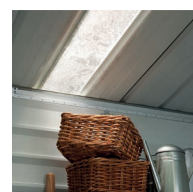

Panneaux de toit translucides*
Translucent roof panels*
* uniquement pour le 1013AEYZ
only for the 1013AEYZ



GAMME WGY

ABRIS MÉTAL IMITATION BOIS
WOOD EFFECT METAL SHEDS

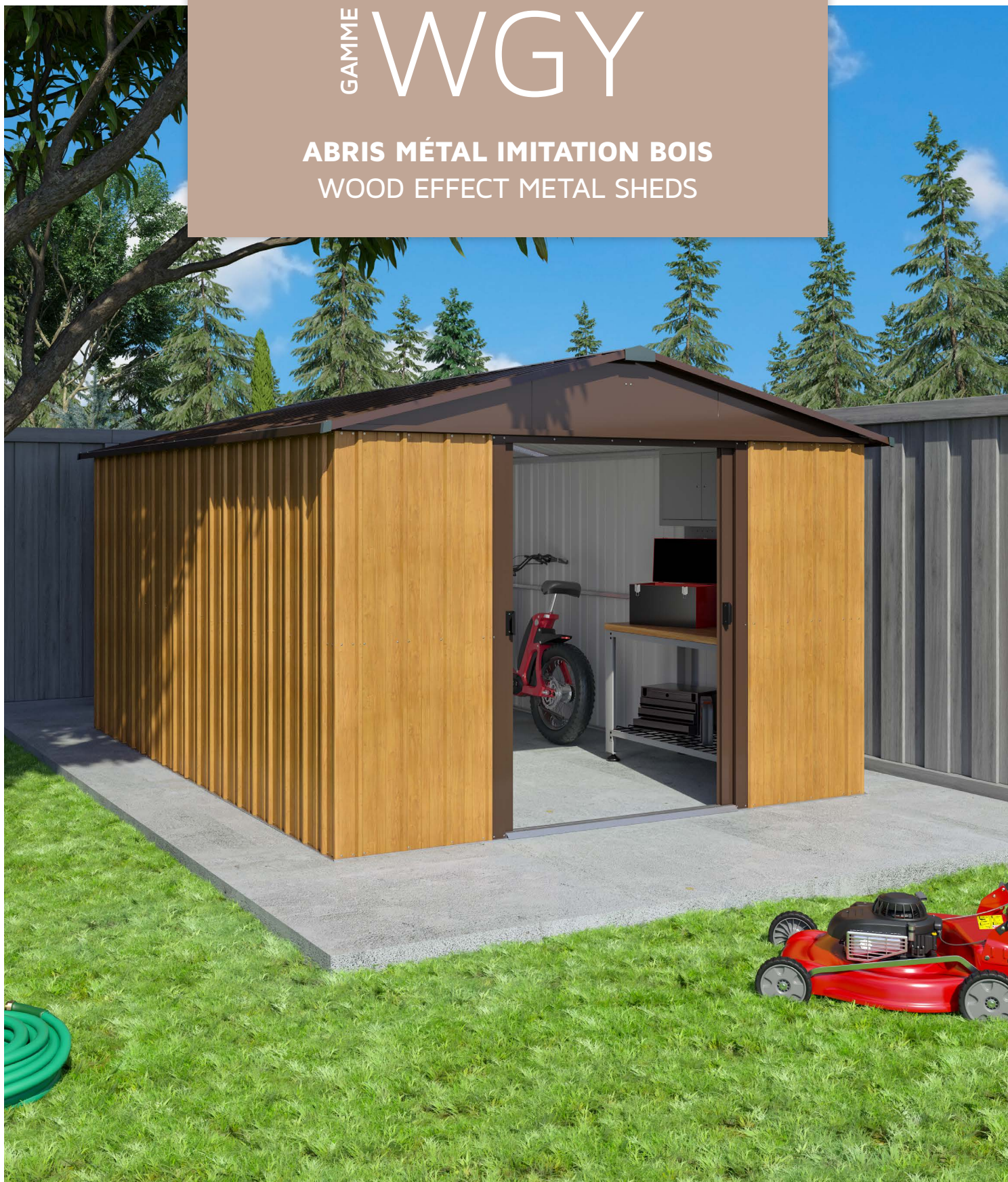

Imitation bois pour un rendu
naturel et harmonieux

Wood imitation for a natural result

KG	PCB MOQ		
66	10	1	168

65WGY

EAN : 3 222 875 706 505

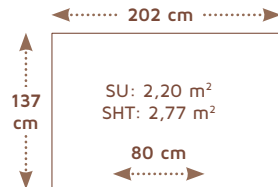

KG	PCB MOQ		
92	6	2	168

106WGY

EAN : 3 222 875 710 601



KG	PCB MOQ		
104	6	2	168

108WGY

EAN : 3 222 874 010 801



KG	PCB MOQ		
159	6	2	168

1013WGY

EAN : 3 222 874 101 301

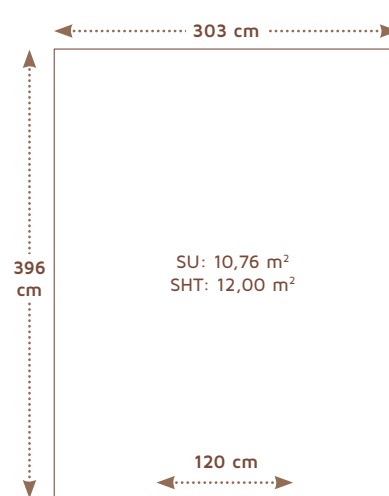

LES + PRODUIT

Advantages of this product



Grandes hauteurs de toit
Lots of headroom



Ventilation le long du toit
Ventilation along roof ridge and eaves



Kit d'ancrage
Anchor kit



Structure de toit renforcée (double poutre)
Reinforced roof structure (double beams)

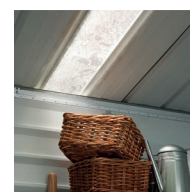

Panneaux de toit translucides*
Translucent roof panels*
* uniquement pour le 1013WGY
only for the 1013WGY



GAMME TBSL

ABRIS MÉTAL BEIGE
BEIGE METAL SHEDS



Couleurs élégantes et design travaillé
pour une intégration harmonieuse dans les jardins

Elegant colours and refined design for a harmonious integration into the gardens

KG	PCB MOQ		
94	6	2	178

86TBSL

EAN : 3 222 872 208 606

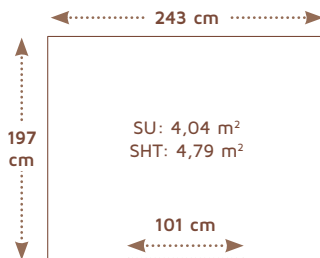

KG	PCB MOQ		
108	6	2	178

106TBSL

EAN : 3 222 872 210 609



KG	PCB MOQ		
120	6	2	178

108TBSL

EAN : 3 222 872 210 807

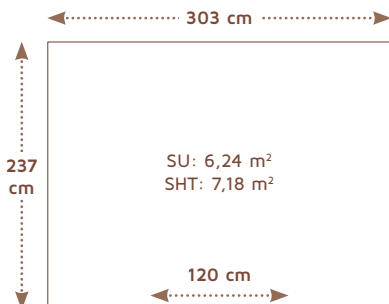

KG	PCB MOQ		
156	6	2	178

1012TBSL

EAN : 3 222 872 210 128

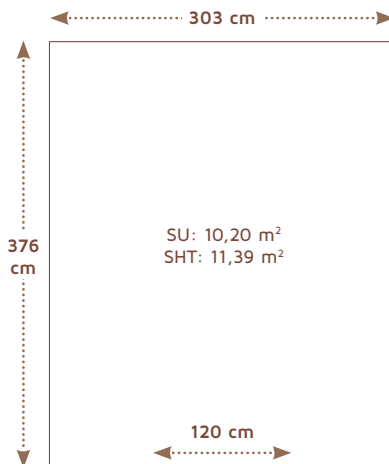

Montage facile !
Easy assembly!

1

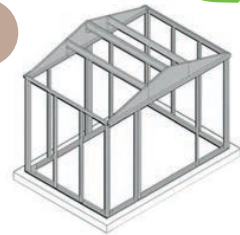

Montage de la structure
Frame setup

2

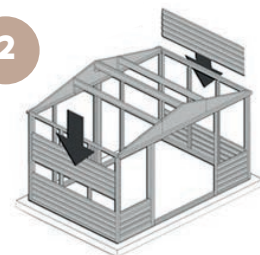

Les panneaux glissent à l'intérieur des profilés
The panels slip perfectly into the rails

3

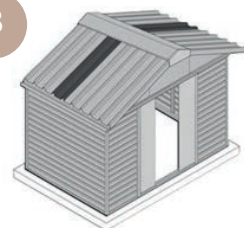

Mise en place et fixation du toit
Roof implementation and fixation

LES + PRODUIT

Advantages of this product

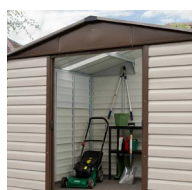

Grandes hauteurs de toit
Lots of headroom



Kit d'ancrage
Anchor kit

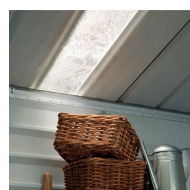

Panneaux de toit translucides*
Translucent roof panels*



Gouttières de toit pour des murs plus propres
Roof guttering helps maintain cleaner walls

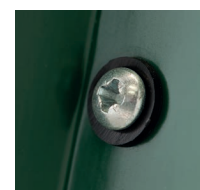

Visserie anti-rouille
Anti-rust screws and bolts



GAMME

GARAGE

GARAGE MÉTAL ANTHRACITE
ANTHRACITE METAL GARAGE



**Solution économique
de stationnement de véhicule**

Economical solution to park a vehicle

KG	PCB MOQ		
220	1	3	176

1017A

EAN : 3 222 871 101 700

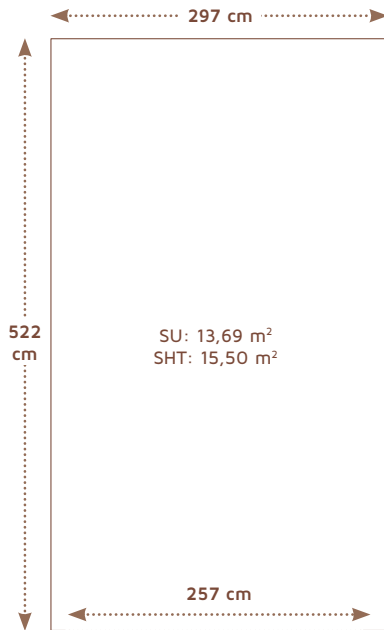

KG	PCB MOQ		
235	1	3	176

1020A

EAN : 3 222 871 102 004

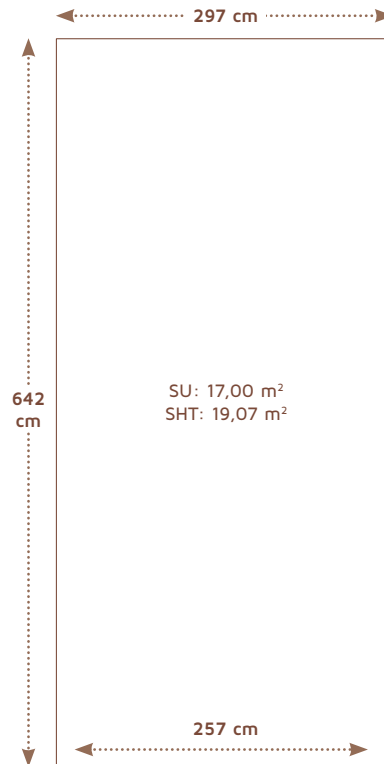

KG	PCB MOQ		
250	1	3	176

1024A

EAN : 3 222 871 102 400

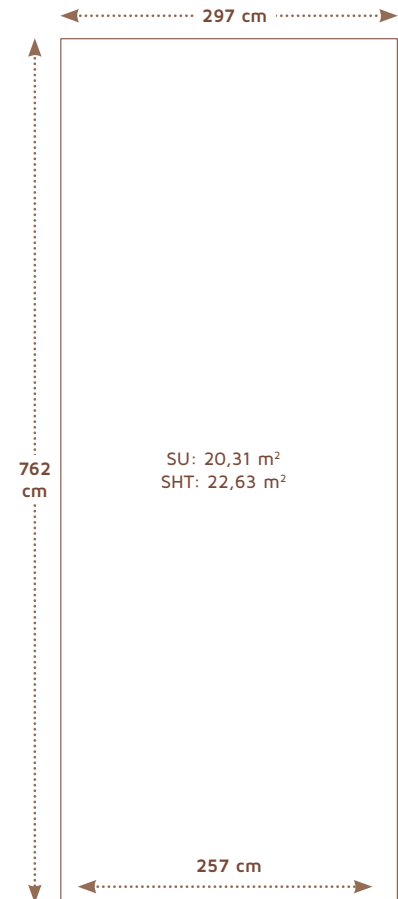

LES + PRODUIT

Advantages of this product

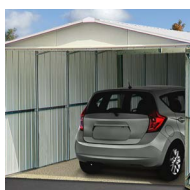
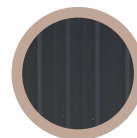

Grandes hauteurs de toit
Lots of headroom



Kit d'ancrage
Anchor kit

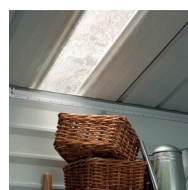

Panneaux de toit translucides*
Translucent roof panels*



Structure de toit renforcée (double poutre)
Reinforced roof structure (double beams)

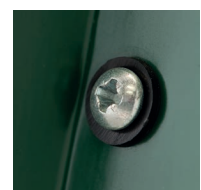

Visserie anti-rouille
Anti-rust screws and bolts

Kits planchers Floor kits



RÉFÉRENCE REFERENCE	KIT PLANCHER FLOOR KIT	GENCOD	PCB MOQ
------------------------	------------------------------	--------	------------

Gamme GPE & GPZ



54GPE	54FK	3 222 871 005 404	x1
64GPZ	64FK	3 222 871 006 401	x1
84GPZ	84FK	3 222 871 008 405	x1
104GPZ	104FK	3 222 871 010 408	x1

Gamme GEYZ



65GEYZ	54FK	3 222 871 005 404	x1
67GEYZ	67FK	3 222 871 006 708	x1
87GEYZ	87FK	3 222 871 008 702	x1
108GEYZ	108FK	3 222 871 010 804	x1
109GEYZ	109FK	3 222 871 010 903	x1
1010GEYZ	1010FK	3 222 871 101 007	x1
1013GEYZ	1013FK	3 222 871 101 304	x1

Gamme AEYZ



65AEYZ	54FK	3 222 871 005 404	x1
67AEYZ	67FK	3 222 871 006 708	x1
106AEYZ	106FK	3 222 871 010 606	x1
108AEYZ	108FK	3 222 871 010 804	x1
1010AEYZ	1010FK	3 222 871 101 007	x1
1013AEYZ	1013FK	3 222 871 101 304	x1

Gamme WGY



65WGY	54FK	3 222 871 005 404	x1
106WGY	106FK	3 222 871 010 606	x1
108WGY	108FK	3 222 871 010 804	x1
1013WGY	1013FK	3 222 871 101 304	x1

Gamme TBSL



86TBSL	68FK	3 222 871 006 807	x1
106TBSL	106FK	3 222 871 010 606	x1
108TBSL	108FK	3 222 871 010 804	x1
1012TBSL	1012FK	3 222 871 101 205	x1

KITS PLANCHERS ASSOCIÉS

(BOIS NON FOURNI)

FLOOR KITS

(PLYWOOD FLOOR
IS NOT INCLUDED)

Montage facile !
Easy assembly!



Pratique !

Permet de stocker
tout en protégeant
de l'humidité !



Convenient!

Allows to store and to
protect at the same
time against humidity !

Dimensions

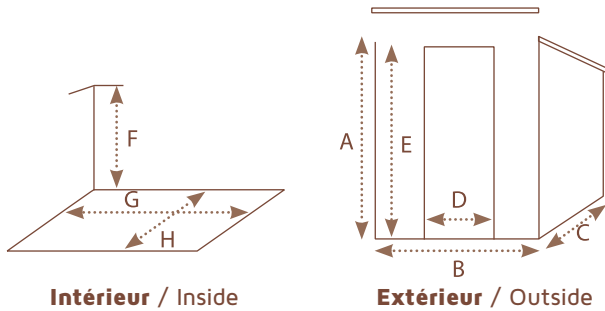

i Les dimensions sur les schémas sont exprimées en centimètres hors-tout. Dimensions on drawings are in cm and overall.

- SHT** Surface hors tout (m²) - Overall surface (m²)
- SU** Surface utile (m²) - Floor area (m²)
- A** Hauteur hors tout (cm) - Overall height (cm)
- B** Largeur débords toit compris (cm) - Width including overhang (cm)
- C** Profondeur débords toit compris (cm) - Depth including overhang (cm)
- D** Largeur porte (cm) - Door width (cm)
- E** Hauteur porte (cm) - Door height (cm)
- F** Hauteur intérieure (cm) - Internal height (cm)
- G** Largeur intérieure (cm) - Internal width (cm)
- H** Profondeur intérieure (cm) - Internal depth (cm)

	DIMENSIONS EXTÉRIEURES (DÉBORDS DE TOIT COMPRIS) OVERALL DIMENSIONS				OUVERTURE DES PORTES DOOR OPENING		DIMENSIONS INTÉRIEURES INSIDE DIMENSIONS			
	SHT	A	B	C	D	E	F	G	H	SU
Gamme GPE / GPZ / SP										
54GPE	1,90 m ²	174 cm	120 cm	158 cm	60 cm	158 cm	160 cm	100 cm	140 cm	1,40 m ²
64GPZ	2,36 m ²	174 cm	198 cm	119 cm	80 cm	158 cm	160 cm	180 cm	100 cm	1,80 m ²
84GPZ	2,84 m ²	174 cm	238 cm	119 cm	102 cm	158 cm	160 cm	220 cm	100 cm	2,20 m ²
104GPZ	3,55 m ²	174 cm	298 cm	119 cm	120 cm	158 cm	160 cm	280 cm	100 cm	2,80 m ²
85SP18	3,78 m ²	210 cm	238 cm	159 cm	102 cm	180 cm	180 cm	226 cm	146 cm	3,29 m ²
Gamme GEYZ										
65GEYZ	2,77 m ²	189 cm	202 cm	137 cm	80 cm	158 cm	160 cm	182 cm	121 cm	2,20 m ²
67GEYZ	4,38 m ²	189 cm	202 cm	217 cm	80 cm	158 cm	160 cm	182 cm	203 cm	3,69 m ²
87GEYZ	5,25 m ²	193 cm	242 cm	217 cm	101 cm	158 cm	160 cm	222 cm	203 cm	4,51 m ²
108GEYZ	7,18 m ²	202 cm	303 cm	237 cm	120 cm	158 cm	160 cm	281 cm	222 cm	6,24 m ²
109GEYZ	8,48 m ²	202 cm	303 cm	280 cm	120 cm	158 cm	160 cm	281 cm	263 cm	7,39 m ²
1010GEYZ	9,03 m ²	202 cm	303 cm	298 cm	120 cm	158 cm	160 cm	281 cm	281 cm	7,90 m ²
1013GEYZ	12,00 m ²	202 cm	303 cm	396 cm	120 cm	158 cm	160 cm	281 cm	383 cm	10,76 m ²
Gamme AEYZ										
65AEYZ	2,77 m ²	189 cm	202 cm	137 cm	80 cm	158 cm	160 cm	182 cm	121 cm	2,20 m ²
67AEYZ	4,38 m ²	189 cm	202 cm	217 cm	80 cm	158 cm	160 cm	182 cm	203 cm	3,69 m ²
106AEYZ	5,97 m ²	202 cm	303 cm	197 cm	120 cm	158 cm	160 cm	281 cm	182 cm	5,11 m ²
108AEYZ	7,18 m ²	202 cm	303 cm	237 cm	120 cm	158 cm	160 cm	281 cm	222 cm	6,24 m ²
1010AEYZ	9,03 m ²	202 cm	303 cm	298 cm	120 cm	158 cm	160 cm	281 cm	281 cm	7,90 m ²
1013AEYZ	12,00 m ²	202 cm	303 cm	396 cm	120 cm	158 cm	160 cm	281 cm	383 cm	10,76 m ²
Gamme WGY										
65WGY	2,77 m ²	199 cm	202 cm	137 cm	80 cm	168 cm	170 cm	182 cm	121 cm	2,20 m ²
106WGY	5,97 m ²	212 cm	303 cm	197 cm	120 cm	168 cm	170 cm	281 cm	182 cm	5,11 m ²
108WGY	7,18 m ²	212 cm	303 cm	237 cm	120 cm	168 cm	170 cm	281 cm	222 cm	6,24 m ²
1013WGY	12,00 m ²	212 cm	303 cm	396 cm	120 cm	168 cm	170 cm	281 cm	383 cm	10,76 m ²
Gamme TBSL										
86TBSL	4,79 m ²	215 cm	243 cm	197 cm	101 cm	178 cm	180 cm	222 cm	182 cm	4,04 m ²
106TBSL	5,97 m ²	224 cm	303 cm	197 cm	120 cm	178 cm	180 cm	281 cm	182 cm	5,11 m ²
108TBSL	7,18 m ²	224 cm	303 cm	237 cm	120 cm	178 cm	180 cm	281 cm	222 cm	6,24 m ²
1012TBSL	11,39 m ²	224 cm	303 cm	376 cm	120 cm	178 cm	180 cm	281 cm	363 cm	10,20 m ²
Gamme GARAGE										
1017A	15,50 m ²	221 cm	297 cm	522 cm	257 cm	176 cm	180 cm	276 cm	496 cm	13,69 m ²
1020A	19,07 m ²	221 cm	297 cm	642 cm	257 cm	176 cm	180 cm	276 cm	616 cm	17,00 m ²
1024A	22,63 m ²	221 cm	297 cm	762 cm	257 cm	176 cm	180 cm	276 cm	736 cm	20,31 m ²

Étendoirs Clothes lines



HÉLIOS

EAN : 3222879600106

L. 10,00 m - l. 0,58 m - h. 1,90 m

PCB MOQ		
12	1	768



Permet de faire sécher le linge
de façon naturelle

Allows natural air-drying of clothes



WINDY

EAN : 3222879600007

L. 10,00 m - l. 0,60 m - h. 1,75 m

PCB MOQ		
15	1	990



6 fils
6 lines

Ø 35 mm



Équipe commerciale

Commercial team

France

POUR COMMANDER, C'EST ICI ! TO ORDER IT'S HERE!

Christophe COURTEILLE

Tél : 06 85 42 59 07

Fax : 02 54 80 76 30

ccourteille@trigano.fr**Fanny DUGUÉ**

Tél : 02 54 73 55 32

Fax : 02 54 80 76 30

televente.jardin@trigano.fr**Commercial France :**

France area sales :

Commerciale sédentaire

Sedentary salesperson

01 / 2A / 2B / 02 / 03 / 04 / 05 / 06 / 07 / 08 / 09 / 10 / 11 / 12 / 13 / 14 / 15 / 16 / 17 /
18 / 19 / 21 / 22 / 23 / 24 / 25 / 26 / 27 / 28 / 29 / 30 / 31 / 32 / 33 / 34 / 35 / 36 / 37 / 38 /
39 / 40 / 41 / 42 / 43 / 44 / 45 / 46 / 47 / 48 / 49 / 50 / 51 / 52 / 53 / 54 / 55 / 56 / 57 /
58 / 59 / 60 / 61 / 62 / 63 / 64 / 65 / 66 / 67 / 68 / 69 / 70 / 71 / 72 / 73 / 74 / 75 / 76 /
77 / 78 / 79 / 80 / 81 / 82 / 83 / 84 / 85 / 86 / 87 / 88 / 89 / 90 / 91 / 92 / 93 / 94 / 95

POUR LE SUIVI ET L'APRÈS-VENTE C'EST ICI !

FOR FOLLOW UP AND AFTER-SALES IT'S HERE!

SERVICE CLIENTS FRANCE

FRANCE CUSTOMER SERVICE

Tél : 02 54 73 55 55

adv.amca@trigano.fr**SERVICE CLIENTS EXPORT**

EXPORT CUSTOMER SERVICE

Tél : + 33 (0)2 54 73 55 54

export2.jardin@trigano.fr**SERVICE APRÈS-VENTE**

AFTER-SALE SERVICE

Tél : + 33 (0)2 54 73 55 60

sav.triganojardin.com

SIÈGE SOCIAL ET USINE : TRIGANO JARDIN - 1, LE BOULAY - 41170 CORMENON - FRANCE

HEADQUARTER AND FACTORY

Europe / DROM

Jamila Zarioh

Tél : + 33 (0)2 54 73 55 54

Fax : + 33 (0)2 54 80 76 30

export2.jardin@trigano.fr

TRIGANO JARDIN



ABRIS DE JARDIN
GARDEN SHEDS

Trigano Jardin, c'est aussi...
Trigano Jardin, it's also...



Des jeux de plein air

*Outdoor games



Des carports

*Carports



Des piscines hors-sol*

*Above-ground pools



TÉLÉCHARGEZ
NOS CATALOGUES

DOWNLOAD OUR CATALOGS

WWW.TRIGANOJARDIN.COM



TRIGANO
JARDIN

1, Le Boulay
41170 CORMENON
FRANCE

Ce document a été imprimé sur du papier 100 % recyclé par l'imprimerie Solidaire, entreprise adaptée qui compte 80 % de salariés en situation de handicap dans ses effectifs de production. L'imprimerie Solidaire répond également aux exigences environnementales avec ses certifications PEFC, FSC® et Imprim'Vert.
©ATELIER DENIS BOMER © EXECCAD